



Disc harrow 4,0m - 4,5m

Date: 19.10.2022

Ziegler-Nr.: 12-094563A Vers. 00 EN Scheibenegge 4m BTA

Ziegler GmbH • Schrobenhausener Str. 56 • 86554 Pöttmes (Germany)
Tel: +49 (0) 8253 / 9997-0 • Fax: +49 (0) 8253 / 9997-47
vertrieb@ziegler-harvesting.com • www.ziegler-harvesting.com

ZERTIFIKAT

DIN EN ISO 9001



PÜG Prüf- und Überwachungsgesellschaft mbH
bescheinigt hiermit, dass das Unternehmen

ZIEGLER

ZIEGLER

Harvesting | Transport | Cultivation

Zertifikatsinhaber: Ziegler GmbH
Schrobenhausener Straße 56, 86554 Pöttmes

Zertifizierte Standorte: + Firmenstandorte (siehe Anlage *)

ein Qualitätsmanagementsystem entsprechend der DIN EN ISO 9001:2015 eingeführt hat und dieses wirksam anwendet.

Der Nachweis wurde im Rahmen des Zertifizierungs-Audits erbracht.

*) Die Anlage ist Bestandteil der Urkunde und umfasst eine Seite.

Dieses Zertifikat ist gültig vom: **04.08.2021**
bis: **03.08.2024**

Zertifikat-Registrier-Nr.: **K24066-20210802-Q-de**



Gäufelden, 02.08.2021



Leitung der Zertifizierungsstelle

Anlage zur Urkunde Seite 2 von 2
vom 02.08.2021

Zertifikat-Registrier-Nr.: K24066-20210802-Q-de

PÜG Prüf- und Überwachungsgesellschaft mbH
Hämmerlestraße 14 + 16, 71126 Gäufelden
Tel. 07032 7808-0, Fax. 07032 7808-50



Das Zertifikat ist gültig für die nachstehend genannten Standorte.

Zertifizierte Standorte

<u>Firmenbezeichnung</u>	<u>Straße</u> <u>PLZ und Ort</u>	<u>Bereiche</u>
Ziegler GmbH	Schrobenhausener Straße 56, 86554 Pöttmes	Strategische Geschäftseinheit Harvesting, Transport, Cultivation, Maschinenbau und Automobiltechnik mit Entwicklung/Konstruktion, Einkauf, Disposition, Logistik und Vertrieb
Ziegler Automobiltechnik spol. S.r.o.	Dr. Klementa 1186 330 23 Nýrany (CZ)	Strategische Geschäftseinheit Harvesting, Transport, Cultivation, Maschinenbau und Automobiltechnik mit Entwicklung/Konstruktion, Einkauf, Disposition, Herstellung, Logistik und Vertrieb
Zieglera Masinbūve SIA	Spalu iela 3 5404 Daugavpils (LV)	Strategische Geschäftseinheit Harvesting, Transport, Cultivation, Maschinenbau und Automobiltechnik mit Entwicklung/Konstruktion, Einkauf, Disposition, Herstellung, Logistik und Vertrieb

Gäufelden, 02.08.2021

Leitung der Zertifizierungsstelle



EG-Konformitätserklärung

Entspricht der EG-Richtlinie 2006/42/EG

EC Declaration of conformity

According to the directive of the EC 2006/42/EC

Wir, **ZIEGLER GmbH**
We, **Schrobenhausener Straße 56**
D-86554 Pöttmes

Erklären in alleiniger Verantwortung, dass das Produkt
Declare under our own responsibility that the product

Maschine: **Scheibenegge aufgehängt**
machine: **Disc harrow suspended**
Modell / model: **ZC Disc Master Pro 4001, 4501**

ab Seriennummer /
from serial number: **4200000**

auf das sich diese Erklärung bezieht, den einschlägigen grundlegenden Sicherheits- und Gesundheitsanforderungen der EG-Richtlinie 2006/42/EG entspricht. Zur sachgemäßen Umsetzung der in den EG-Richtlinien genannten Sicherheits- und Gesundheitsanforderungen wurden insbesondere folgende Normen und technische Spezifikationen herangezogen:

To which this declaration refer are in conformity with the applicable basic safety and health requirements of EC Directive 2006/42/EC. In order to fulfil the safety and health requirements contained in the EC Directives, the following standards and technical specifications have been taken into account:

EN ISO 12100 Sicherheit von Maschinen
EN ISO 4254-1 Landmaschinen Sicherheit Teil 1

Bevollmächtigt zur Zusammenstellung der technischen Unterlagen ist der unterzeichnende Geschäftsführer.
The company officer authorized for the compilation of the technical documentation is the Managing Director (signatory).

Dieses Zertifikat belegt, dass auch einzelne Anbauteile mit den grundlegenden Sicherheitsvorgaben (gemäß der EU-Richtlinie 2006/42/EG) rechtskonform sind und bei der Montage an Mähdreschern und an anderen Geräten mit dem CE-Zeichen gekennzeichnet werden dürfen.

This certificate gives the right to declare on the conformity of partly completed equipment with the essential safety stated in EU Directive 2006/42/EC in assembly with combine harvesters and to mark equipment with CE mark.

Pöttmes, den 01.12.2021
Ort und Datum; Place and date

ZIEGLER
Ziegler GmbH
86554 Pöttmes • Schrobenhausener Straße 74
Tel. 08253/9997-0 • Fax 08253/9997-47

Dipl. BW (FH) M. Ziegler
(Geschäftsführer)

To guarantee the handover of the operating instructions to the end customer and the reseller.

Date of delivery _____

Please a completed copy of this form to
ZIEGLER GmbH, Schrobenhausener Straße 56, D-86554 Pöttmes (Germany)

Address authorized stockist / importer

Company

Address

Town / postcode

Company stamp / date

Customer address

Name

Address

Post code

I hereby declare that I have purchased the machine / set specified below. I also confirm that I was presented with the operating instructions upon delivery of the machine / set. I undertake to read these operating and installation instructions comprehensively and carefully before use of the machine / set. Moreover, I undertake to commission and operate the machine / set in accordance with their contents. I will also include these documents with the machine / set in the event of its resale and inform the buyer of the obligation to pass on the instructions with the machine. I am aware that a guarantee claim can be made against ZIEGLER GmbH only after ZIEGLER GmbH have received a completed and signed version of this declaration. Furthermore, I am aware that the guarantee period begins with the date on which I took receipt of the machine / set, regardless of the date on which this declaration was returned.

Machine / set type

Machine / set no.

Place / date

Customer signature

Guarantee payments can only be made upon provision of a completed and signed handover declaration.

1.	FOREWORD	10
2.	INTRODUCTION	11
2.1	Intended use	11
2.2	Validity	11
2.3	Contact partner	11
3.	SAFETY	12
3.1	Identification of advice in this operating instructions	12
3.2	Identification of danger signals	12
3.3	Personnel qualification and training	12
3.4	Dangers due to non-compliance with safety instructions	12
3.5	Safety conscious working	12
3.6	Safety and accident prevention regulations	13
3.7	Attached devices	13
3.8	Hydraulic system	14
3.9	Maintenance	15
3.10	Unauthorized alterations and production of spare parts	15
3.11	Inadmissible modes of operation	15
3.12	Safety instructions on the machine	15
3.13	Meaning of safety labels	16
4.	TECHNICAL DATA AND LABELLING	17
4.1	Type plate	17
4.2	Details for enquiries and orders	17
4.3	Intended use	17
4.4	Technical data	18
4.5	Overview of machine	19
5.	INSTALLATION	20
5.1	Transport in general	20
5.2	Attach / detach machine	21
6.	OPERATION	21
7.	MAINTENANCE AND CARE	25
7.1	Storage	28
7.2	Lubrication schedule	28
7.3	Definition of terms	28
7.4	Lubrication points	28
8.	DISPOSAL	29
9.	TIGHTENING TORQUE FOR SCREWS	30

1. FOREWORD

Dear customer,

In purchasing our disc harrows, you have decided for a high-quality ZIEGLER product.

We would like to thank you for your confidence in buying this product.

Please read these operating instructions carefully and before use in order to ensure the best possible use of the disc harrows.

This manual has been structured in order to provide comprehensive information about the required activities following the technical sequence. It provides comprehensive information concerning the maintenance, the safe operation of the machine, safe working methods, special precautionary measures and the additional accessories available. Compliance with the specifications contained in this manual is vital in order to ensure operational safety, reliability and value-conservation of the disc harrows.

Please note

This manual also refers to the disc harrows as the “machine” or “front attachment device”.

Please note:

These operating instructions represent a constituent part of the machine and must be stored in immediate proximity to it.

Only ever operate the machine after full training and in compliance with the specifications of this manual. It is absolutely necessary that you adhere to the safety information.

Please comply with all the applicable accident prevention regulations and all generally-recognized safety and medical-safety regulations and the applicable highway code.

All the information, diagrams and technical specifications made in these operating instructions correspond to the latest state of technology at the point of publication.

We reserve the right to make alterations to the design at any time and without the need to specify reasons. Should these operating instructions become completely or partially unusable, we will provide you with a replacement. Please state the number on the next page.

We wish the best of success with your disc harrows.

Ziegler GmbH

2. INTRODUCTION

These operating instructions contain the basic information which must be adhered to during the operation and maintenance of your machine. All personnel must read these operating instructions before commissioning the machine. Therefore they are to be held accessible to personnel at all times.

Please follow all the safety information provided in these operating instructions and not just those listed under the special safety headings.

2.1 Intended use

The Ziegler disc harrows DISC MASTER PRO is a front attachment for tractors for shallow soil cultivation.

2.2 Validity

These operating instructions are valid for the disc harrows DISC MASTER PRO

2.3 Contact partner

Ziegler GmbH
Schrobenhausener Straße 56
D-86554 Pöttmes (Germany)

Telefon: +49 (0) 8253/9997-0 (switchboard)

Telefax: +49 (0) 8253/9997-47

E-Mail: vertrieb@ziegler-cultivation.com

Internet: www.ziegler-cultivation.com

3. SAFETY

3.1 Identification of advice in this operating instructions

The safety advice provided in these operating instructions which can cause danger to personnel in the case of non-compliance is marked with general danger symbols:

3.2 Identification of danger signals

Danger!

	DANGER! –Type and source of the danger!
	Impact: Danger to life or of serious injuries. ➤ Measures for danger prevention

Warning!

	WARNING! – Type and source of the danger!
	Impact: Injuries, serious damage to material. ➤ Measure for damage limitation

Caution!

	WARNING – Type and source of the danger!
	Impact: Material damage ➤ Measure for damage limitation

Please note

	PLEASE NOTE – Type and source of the danger!
	Impact: Economic use of the machine ➤ Measures to be performed

Warnings placed directly on the machine always require compliance and are to be maintained in a completely legible manner.

3.3 Personnel qualification and training

The machine may only be used, serviced and repaired by those who are familiar with it and have been informed about the dangers involved. The area of responsibility, responsibility and monitoring of personnel have to be regulated clearly by the owner. Personnel lacking any requisite knowledge must be trained and instructed. The owner has to ensure that the personnel has read and understood entirely the specifications of the operating instructions.

Repair work not described in these operating instructions may only be performed by an authorized specialized garage.

3.4 Dangers due to non-compliance with safety instructions

Non-compliance with the safety instructions can result in threats for persons, environment and the machine itself. In addition it can result in loss of all liability cover.

Non-compliance can result in the following threats:

- Threats to persons due to unsecured working areas
- Failure of important machine functions
- Failure of the prescribed methods of maintenance and repair
- Threat of persons due to mechanical and chemical influences
- Threat of the environment due to leakage of oil

3.5 Safety conscious working

The safety instructions, existing instructions to accident prevention as well as internal work and safety instructions of the operator have to be considered.

The health and safety and accident-prevention regulations of the appropriate professional associations are mandatory.

The safety information of the vehicle manufacturer must be adhered to as well as the relevant highway code when driving on public highways (in Germany StVZO and StVO)

Be prepared for any emergencies. Maintain fire extinguishers and First-Aid kits within reach. Hold the emergency numbers for medical and fire services available.

3.6 Safety and accident prevention regulations

- In addition to the information contained in these operating instructions, comply with all the generally-valid safety and accident-prevention regulations
- Warning signs provide important information required for danger-free operation. Compliance serves your safety.
- Comply with all traffic regulations when using public highways.
- Please ensure that you familiarize yourself with all the features and operating elements as well as their function before commencing work. It is too late to do so whilst working!
- Operating personnel should wear tightly-fitting clothing. Avoid wearing any loose clothing.
- Keep the machine clean in order to minimize the danger of fire.
- Check the immediate surroundings before activating and commissioning (Children!) Ensure sufficient visibility.
- It is forbidden to ride on the working device and attachment during work.
- Couple the devices as prescribed and only fix and secure to the prescribed equipment.
- Bring the support equipment into the respective position during attaching and detaching
- Pay special attention when coupling and uncoupling the disc harrows to or from the tractor.
- Always couple the ballast weights to the intended attachment points in accordance with the specifications.
- Comply with the permissible axle loads, total weight and transport dimensions.
- Check and install the transport equipment such as lighting, warning equipment and if necessary, the safety equipment.
- The actuation equipment (ropes, chains, rods etc.) of remote controlled units must be installed in such a way that they do not trigger unintended movements in all transport and working positions.
- Bring the tractor into the prescribed state for road travel and lock in accordance with the relevant specifications.
- Never leave the driver's cab during work.
- The travel speed must always be adapted to the surrounding conditions. Avoid sudden turning manoeuvres during hill and valley travels as well as during transversal movements on slopes.
- Handling, steering and braking are influenced by the installation of the devices and the addition of ballast weight. Ensure sufficient steerability and brake capacity.
- Pay attention to the wide projection and / or the oscillating weight of the device when travelling on curves.
- Only ever operate the disc harrows once all safety equipment have been installed and are in the protection position.
- Maintain safety equipment in a good state. Replace missing or damaged parts.
- It is forbidden to remain in the work area.
- Do not remain in the turning and pivoting area.
- The hydraulic folding frame may only be actuated once there is no-one in the pivoting area.
- Danger of crushing and shearing at remote-actuated parts (e.g. hydraulics).
- Before leaving the tractor, set down the disc harrows on the ground, engage the parking brake, switch off the motor and remove the ignition key.
- It is forbidden to remain between the tractor and disc harrows without the parking brake and stop block being activated in order to stop the vehicle from rolling away.
- Follow all the further safety information in the tractor's operating instructions

3.7 Attached devices

- Special attention must be paid when coupling and uncoupling the disc harrows to or from the tractor.
- The disc harrows may only be attached to the type of tractor intended for use.
- By coupling machines to the front or rear of a tractor, the following aspects must not be exceeded
 - permitted total tractor weight
 - permitted tractor axle weight
 - permitted tyre load of tractor tyres
- Safeguard the tractor and machine against unintentional movement before coupling and uncoupling the machine
- When coupling and uncoupling the machine, move support devices (if available) into the appropriate position (stability!)
- By operating the support devices, a risk of injury from crushing and shearing points occurs.

- Special attention must be paid when coupling and uncoupling the machine to the tractor! Crushing and shearing points exist in the area around the coupling point between the tractor and the machine.
- It is forbidden to remain between the machine to be coupled and the tractor while the tractor is approaching the machine
- Work on the disc harrows may only be performed with the motor switched off and the ignition key removed. All control levers should be in neutral position and none of the hydraulic lines should be under pressure.
- Never perform work under a raised disc harrows
- The disc harrows must always be placed into the transport position for transport on public streets. The lighting (if available) must be connected. Repair works, maintenance, cleaning work as well as fault repair may only be performed with drive and engine stopped. Remove ignition key!
- Liquids emerging under pressure (hydraulic oil) can penetrate the skin and cause serious injuries which are not visible from outside. See a hospital immediately after injuries. Danger of infection!
- Operating materials such as waste oils have to be disposed properly.
- Repair work of the hydraulic installation can only be performed by special repair garages.

3.8 Hydraulic system

- The hydraulic system is under pressure.
- When connecting hydraulic cylinders and motors, ensure that you connect the hydraulic hoses in the correct way!
- Before performing any work on the hydraulic system, sink all hydraulically raised parts to the ground. Set the hydraulics pressure-free on the tractor and device side.
- When connecting the hydraulic hoses to the hydraulic connections of the chopper, make sure that the hydraulics are depressurized on both sides.
- Given hydraulic function connections between the tractor and the front attachment, ensure that the coupling sleeves and plugs are marked in order to prevent incorrect operation. Swapping the connections of the opposite functions (e.g. raising and sinking) brings the DANGER OF ACCIDENT.
- The hydraulic hose lines are subject to regular checks and replacement if damaged or worn. All replacement hose lines must meet the technical requirements of the device manufacturer.
- Use suitable resources when searching for leakage in order to prevent.
- Liquids emerging under pressure (hydraulic oil) can penetrate the skin and cause serious injuries. Consult a doctor immediately after injuries. Danger of infection
- Make sure that the hydraulic system has been depressurized and switch off the motor before performing any work on the hydraulic system!

3.9 Maintenance

- Repair, maintenance and cleaning work and the elimination of malfunctions should only be performed once the drive has been switched off and the motor is at a standstill - Remove the ignition key.
- Test all nuts and screws for their tightness and tighten if necessary.
- When performing maintenance work on the raised machine, make sure that it is secured with appropriate support elements.
- Dispose oils, grease and filters correctly.
- Always disconnect the electrical system from the power supply before commencing work.
- If protection devices are subject to wear, regular checks and replacements have to be made.
- When performing electrical welding work on the vehicle and connected devices, disconnect the power supply via the battery main switch or the cable on the generator and pinch off the battery.
- The spare parts must correspond at least to the manufacturer's technical specifications. This is guaranteed by original ZIEGLER spare parts.
- When replacing the cutting tools, use appropriate tools and wear suitable gloves!
- Do not wash new machines with a steam jet or a high-pressure cleaner. The coating requires c. three months to harden and could suffer damage.

3.10 Unauthorized alterations and production of spare parts

Alterations or changes of the machine are only permitted after consultation the manufacturer. ZIEGLER original spare parts and manufacturer-authorized accessories serve the machine's security. Using other parts can invalidate the liability for the resulting consequences.

3.11 Inadmissible modes of operation

The operating safety of the machine is only guaranteed by its intended use in accordance with the chapter "Introduction Intended use" of the operating instructions. The threshold values specified in the data sheets must never be exceeded.

3.12 Safety instructions on the machine

The ZIEGLER front attachment device is equipped with all the necessary safety equipment. Not all danger points on this machine can be secured entirely against function-loss. The corresponding safety instructions, which point to the remaining residual dangers, are placed on the machine. The danger instructions have been presented in the form of so-called warning symbols. The following section provides information about the position of these warnings.

The safety information on the machine warn against residual dangers. They consist of warning symbols and work safety symbols. Please follow all the safety information. Safety instructions must always be maintained in a clean and easily-legible state. Should the safety information suffer damage or should get lost, order replacements from the supplier and install them on the intended locations. The position and meaning are described in the following section.



DANGER! – Danger area of the machine

Impact. Danger to life or of serious injuries.

- Replace damaged or illegible labels immediately.
- Affix the corresponding safety labels to all repaired, replaced or otherwise altered components.
- Never use a high-pressure jet to clean areas to which a safety label has been affixed.
- Familiarize yourself with the meaning of the warning symbols. The text next to it and the selected position for the labels provide information for the special danger areas on the machine.

3.13 Meaning of safety labels



<p>Dangers of suffering blows and crushing between the rear end of the tractor and the machine when coupling and uncoupling the machine</p>	<p>Only touch the machine components once they have reached a complete standstill</p>	<p>Read and adhere to the operating instructions and the safety instructions before commissioning</p>	<p>Exercise caution with liquid issued under high pressure. Comply with the specifications of the technical manual.</p>
<p>Do not remain under an unsecured suspended load</p>	<p>Do not stand in the swivel range of devices</p>		

4. TECHNICAL DATA AND LABELLING

All the information, diagrams and technical specifications made in these operating instructions correspond to the latest state of technology at the point of publication. We reserve the right to make alterations to the design at any time and without the need to specify reasons.

4.1 Type plate



Fig. 2

4.2 Details for enquiries and orders

Year of construction:	
SN:	
Type:	

Retailer's address:

Name:	
Street:	
City:	
Phone.:	
Cust. No. retailer:	

The entire labelling has the status of an official document and may not be altered or changed beyond recognition!

Should you have questions about the machine or when ordering spare parts, state the type label, serial number and the year of construction of the corresponding machine. We recommend that you enter this information in the fields above so as to ensure their availability.

 Please note

ZIEGLER original spare parts and manufacturer-authorized accessories serve the security of the machine. The use of spare parts, accessories and other devices not produced, tested or authorized by ZIEGLER will result in loss of liability for the resulting damage.

Take the corresponding article numbers for the spare parts list.

4.3 Intended use

The disc harrows DISC MASTER PRO may only be attached to transport vehicles which the respective adapter frame has been authorized for (follow the operating permission of the bearer vehicle). It is exclusively to be used for conventional agricultural operations (intended use); please consult the chapter introduction "Intended use".

Any other form beyond these specifications and is classed as non-intended use. The manufacturer is not liable for any damage resulting from this form of use. The risk is borne by the operator alone.

Intended use includes the maintenance of the operating, maintenance and servicing conditions specified by the manufacturer.

Unauthorized alterations made to the machine can exert a negative influence on the machine and impair the orderly function. Unauthorized alterations release the manufacturer from any resulting liability claims.

4.4 Technical data

All the information, diagrams and technical specifications made in these operating instructions correspond to the latest state of technology at the point of publication.

We reserve the right to make alterations to the design at any time and without the need to specify reasons.

Secifications	4001	4501
Working width (m)	4,00	4,50
Number of discs	32	36
Disc diameter (cm)	56	56
Line distance (cm)	22,5	22,5
Beam distance (cm)	90	90
Frame height (cm)	80	80
Power requirement (PS)	130	150
Weight (kg)	2680	2840

4.5 Overview of machine

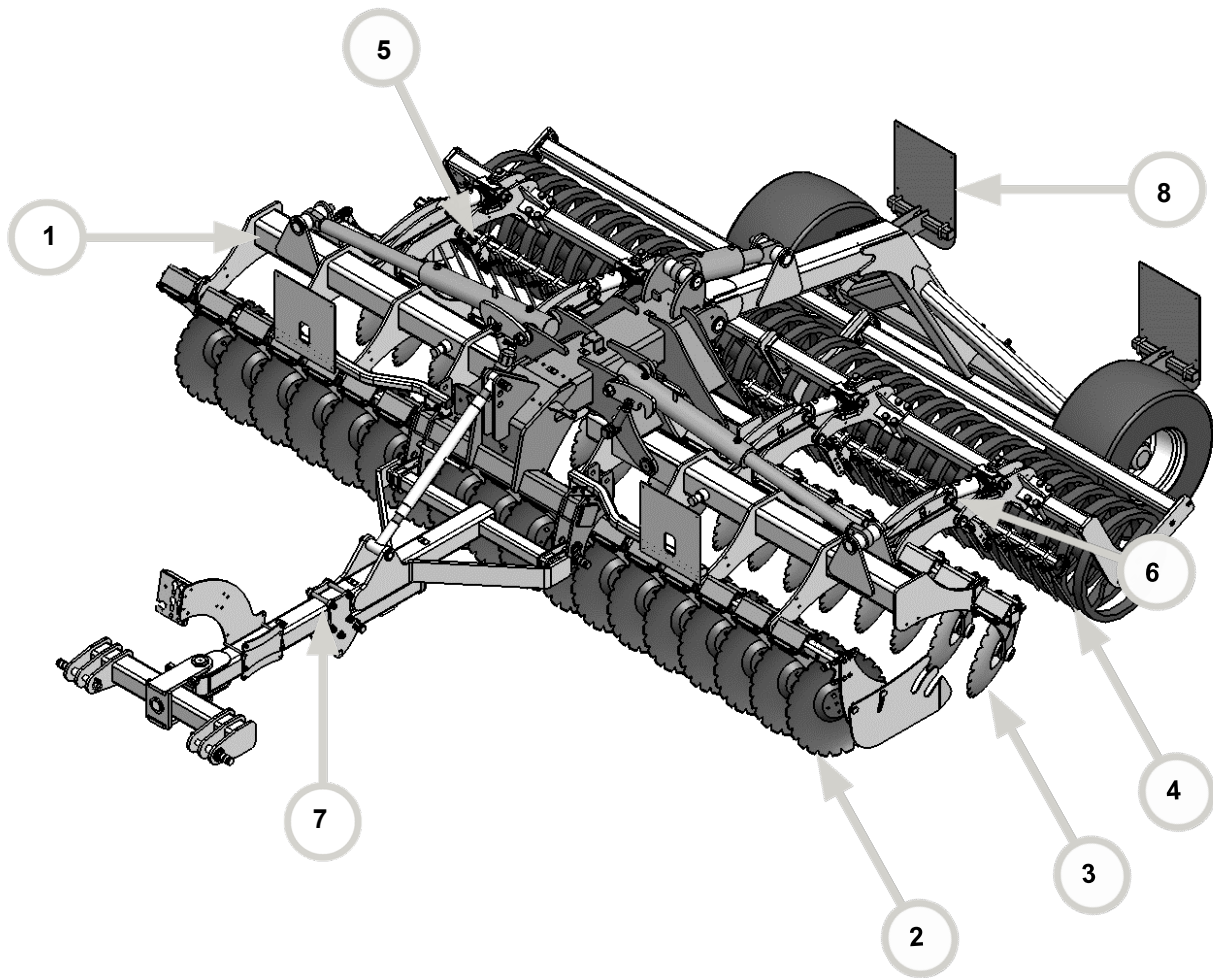



Fig. 3

Front view



- 1. Basic unit
- 2. Disc row I
- 3. Disc row II
- 4. Roller
- 5. Harrow (option)
- 6. Hydraulic depth guide (optional)
- 7. Chassis inc. drawbar (optional)
- 8. Lamp holder in accordance with STVO (German Highway Code no fig.: APV spreader with foot plate and handrail (optional))

5. INSTALLATION

	<p>DANGER! – machine can tip!</p>
	<ul style="list-style-type: none"> ➤ Impact: Danger to life or of serious injuries. ➤ Secure the machine correctly with tension belts ➤ Ensure that the machine has a firm position and let it down slowly. ➤ Ensure sufficient chain tension. ➤ Switch off the motor and activate the lowering lock before commencing any work on the machine ➤ Persons are not allowed to remain in the danger zone ➤ Use sufficient lifting gear ➤ Follow the regulations for lifting gear

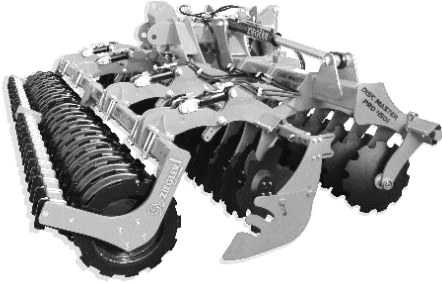

	<p>Caution! – Do not exceed permitted transport height!</p>
	<p>Impact: material damage</p> <ul style="list-style-type: none"> ➤ Pay attention to transporting height when entering doors or crossing bridges

5.1 Transport in general

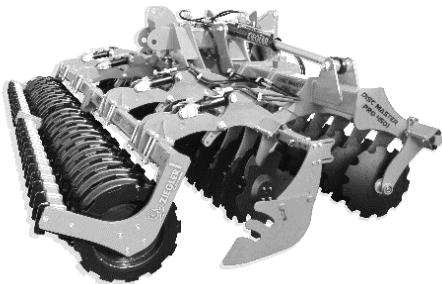
 <p>Fig. 4</p>	<p>Internal transport by crane</p> <p>adhere to permitted sizes and weights block lower link of sideways swings only use suitable lifting gears for transport.</p> <p> Safeguard machine's firm position!</p>
--	--

 <p>Fig. 5</p>	<p>Transport by lorry</p> <p>Secure the disc harrows with tension belts from dropping corresponding to local regulations.</p>
---	--

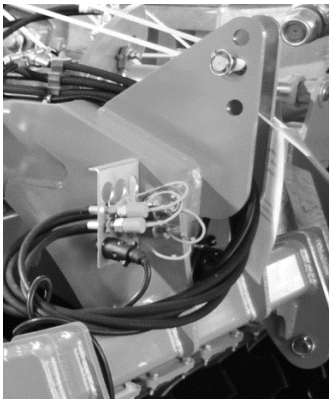
5.2 Attach / detach machine

 <p>Fig. 6</p>	<p>Attach / detach machine</p> <p>Attach disc harrows at tractor's three point. If necessary, lock the lower link against sideway swinging and connect lightings.</p> <p>When parking, disengage hydraulic coupling and disconnect lighting. Detach disc harrows.</p> <p> Safeguard machine's firm position! People are not allowed to remain in the danger zone.</p>
---	--

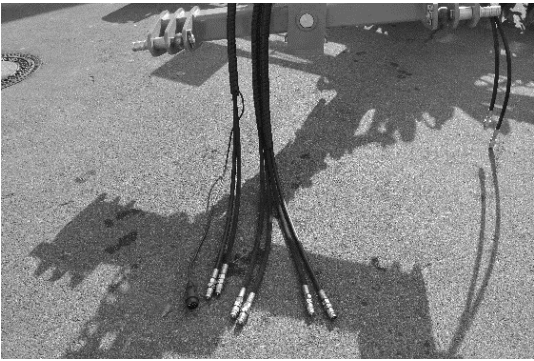
 <p>Fig. 7</p>	<p>Connecting the chassis inc. drawbar (optional)</p>
--	--

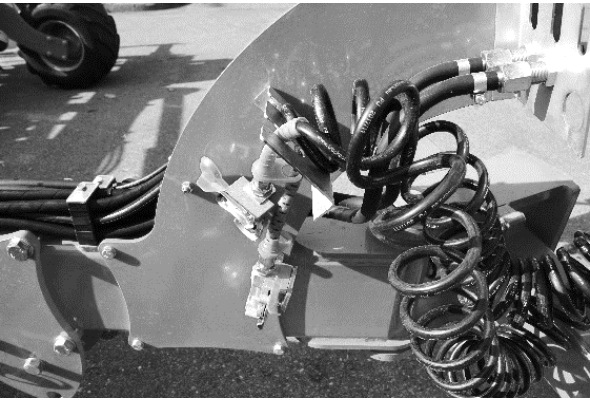
 <p>Fig. 8</p>	<p>Connecting the chassis inc. drawbar</p>
---	---

6. OPERATION

	<p>Caution! – Transport exceeded width!</p> <p>Impact: material damage</p> <ul style="list-style-type: none"> ➤ Fold in the disc harrow for road transport
---	--



Fig. 9

Fold in the disc harrow for road transport.



Before commissioning:

Lubricate all lubrication nipples

Test all bolts and nuts for their security and tighten if necessary

	rod roller	roof ring roller	U profile roller	double U profile roller	spring stamp roller	steel ring roller
Weight /kg						
Ø mm	600	600	540	540	550	600

Fig. 10

Trailer roller

Depending on the design, a rod roller, roof ring roller, spring stamp roller, steel ring roller U profile roller and double U profile can be installed. The trailer roller provides a restabilization and a fine crumble-structured surface.

Please clean dirty trailer rollers polluted by road travels.



Fig. 11

Rod roller

The large, screw form of the open rod roller with its arrangement of pipes provides very high load capacity with a low weight. It is ideal for dry and light to medium-difficulty conditions.



Fig. 12

Roof ring roller

With its sharp edges, the v-ring roller breaks up soil clumps well. Broad shoulders prevent sinking in to the ground under dry or light conditions. The roller is highly suited to heavy and medium ground. Settable scrapers are provided for damp conditions.



Fig. 13

U profile roller

With a diameter of 540 mm and 12.5 cm gaps between the rings, it is suitable for nearly all ground soils. The U profile opening outwards towards the ground ensures minimal wear. The earth which sticks to the U profile protects the packer rings. The open packer rings permits deeper solidification.



Fig. 14

Double U profile roller

With a diameter of 600 mm and 8 cm gaps between the rings, it is suitable for nearly all ground soils. The U profile opening outwards towards the ground ensures minimal wear. The earth which sticks to the U profile protects the packer rings. The open packer rings permits deeper solidification.



Fig. 15

Spring stamp roller

The spring stamp roller consists of four replaceable springs per ring. The constant vibration of the spring elements makes the spring stamp roller insensitive to damp conditions, yet still produces a lot of fine earth under dry and hard conditions. The spring stamp roller can be fitted with scrapers to meet special requirements.

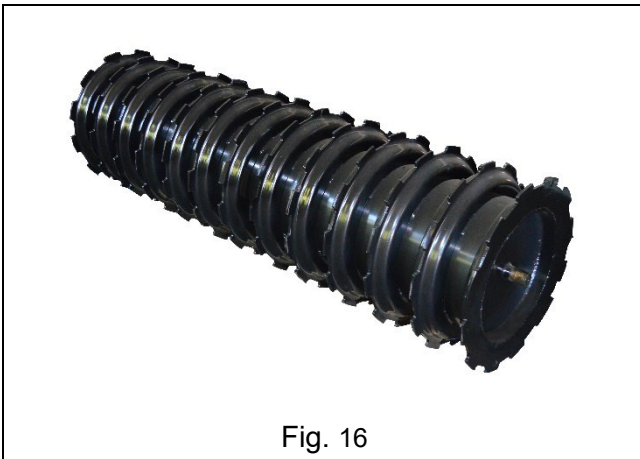

Fig. 16

Steel ring roller

With a 460 mm interior pipe and a 600 mm exterior diameter, the Ziegler steel ring roller is suitable for almost all conditions. The combination of cutting edge and a broad shoulder makes for good solidification. The wide spacing of the rings leaves a number of areas uncompacted; as a result, they can take up precipitation well and dry easily.

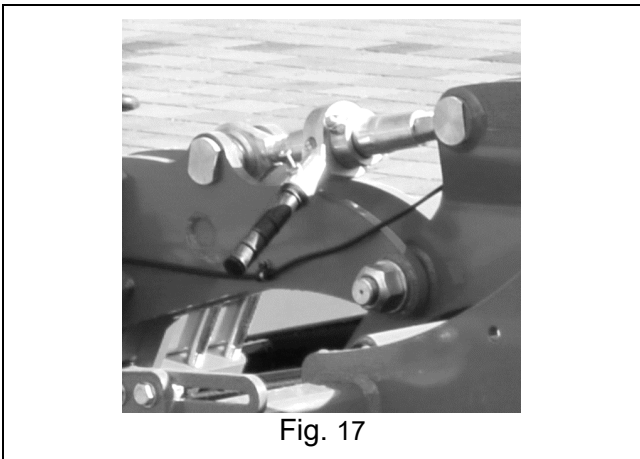

Fig. 17

Mechanical depth control

The working depth can be controlled infinitely variable to up to 15 cm with a ratchet. The embedded scale facilitates the adjustment.

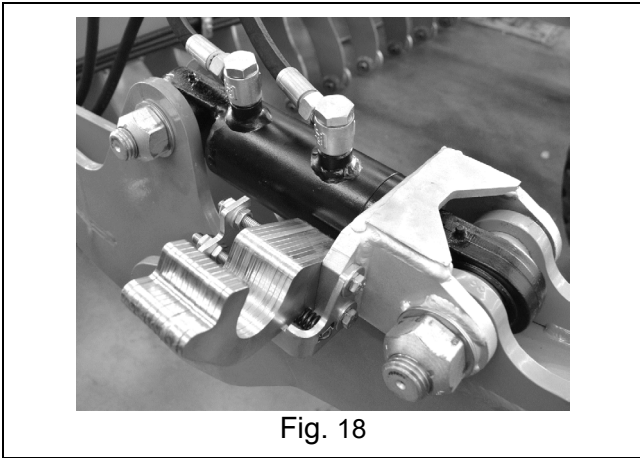

Fig. 18

Hydraulic depth control (optional)

A double-acting control unit regulates the depth adjustment from the cab. Pivoting spacer discs facilitate the exact adjustment.

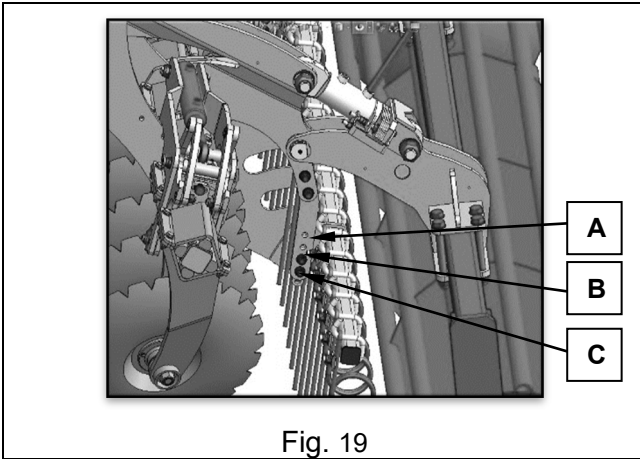



Fig. 19

Harrow (optional)

The disc harrows DISC MASTER PRO can be equipped in the middle with a harrow (optional). This spreads the crop residues and loosens the surface. The harrow's movements can be adjusted up and down via hole pattern.

Hole pattern (A) restricts the movement to go up,
 Hole pattern (B) setting middle.
 Hole pattern (C) restricts the movement to go down
 During field operation the right adjustment has to be figured out. Please do not strain the harrow more than necessary.

7. MAINTENANCE AND CARE

	<p>DANGER! – during maintenance work, falls are possible</p>
	<p>Impact: danger to life or of serious injuries.</p> <ul style="list-style-type: none"> ➤ When getting on the machine, do not step on the roof ring roller or other pivotable parts. ➤ Please wear cut resistant security gloves

	<p>DANGER! – accidental hydraulic movements – Unintended lowering of the machine lifted by the tractor's three point hydraulic system. – Unintended lowering of lifted unsecured machine parts. – Unintended starting and rolling of the tractor-machine-combination.</p>
	<p>Impact: danger to life or of serious injuries.</p> <ul style="list-style-type: none"> ➤ Switch off tractor completely, remove ignition key, secure against switch-on (BA of tractor)

	<p>Caution – contact with oils and grease</p>
	<p>Impact: injuries</p> <ul style="list-style-type: none"> ➤ Avoid skin contact with oils, grease, detergents and solvents ➤ Immediately see a doctor after injuries or acid burns caused by detergents or solvents <p>In order to avoid injuries and accidents, adhere to all other security instructions</p>

	<p>Please note! – maintenance and care intervals!</p>
	<p>Impact: machine's economic benefit</p> <ul style="list-style-type: none"> ➤ In order to guarantee flawless use of the machine and to reduce wear, special maintenance and service intervals have to be complied. This includes cleaning, oiling, lubricating and greasing of components ➤ Check nuts and screws for tightness and retighten if necessary (approx. every 50 hours) ➤ Please do not clean new machines with steam jets or high pressure jets. The machine's paint is dried after 3 months and could therefore be damaged.



Fig. 20

Discs

The bearings are maintenance free

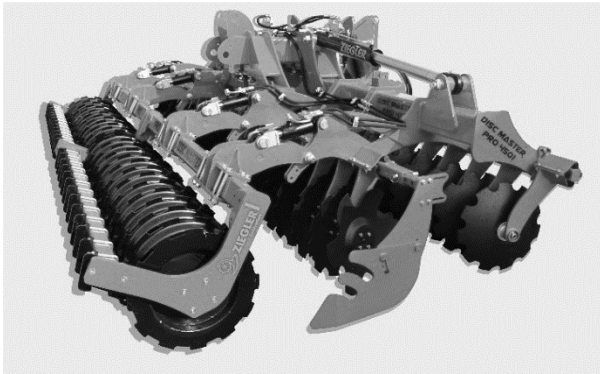

Fig. 21

Trailer roller

Check if trailer roller, wiper and bearings are tight and run smoothly.
Check wiper's wear and renew wiper if necessary.
Check adjustment of wiper and readjust if necessary.

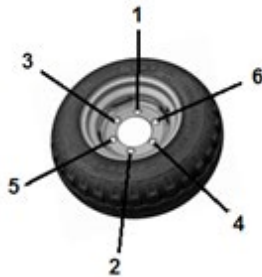

Fig. 22

Check the wheel nuts and the tightening torques.

Caution:

Comply with the sequence indicated when loosening and tightening the wheel nuts. After fitting, check the wheel nuts after 10 operating hours and tighten if necessary. Then check them for security after 50 operating hours. Check the tyre pressure at regular intervals and replenish if necessary. The tyre pressure depends on the tyre size.



Air pressure of the tyres

Tyre types R 400/60-15.5 3,6 to max. 4 bar

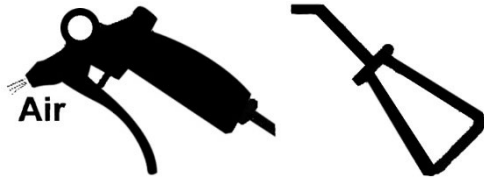

Fig. 23

General instructions

Fundamentally, all movable parts need to be lubricated and checked within the scope of general mechanical engineering.

Regular cleaning and removal of deposits serves the purpose of value retention and safety.

Not particular mentioned parts which are subject to regular or irregular movements have to be lubricated and greased as well periodically.

After the harvesting process, all bright metallic parts need to be protected against rust.

Lubricant: oil (customary)

7.1 Storage

 Fig. 24	<p>Before storage, the machine needs to be cleaned carefully from residues. Please store machine under a roof if possible. Protect machine against rust. Please use biodegradable sprays and oils only, e.g. rapeseed oil.</p> <p>Synthetic material and rubber parts shall not be sprayed with rust protection. The parts can become brittle and can break</p>
--	--

7.2 Lubrication schedule

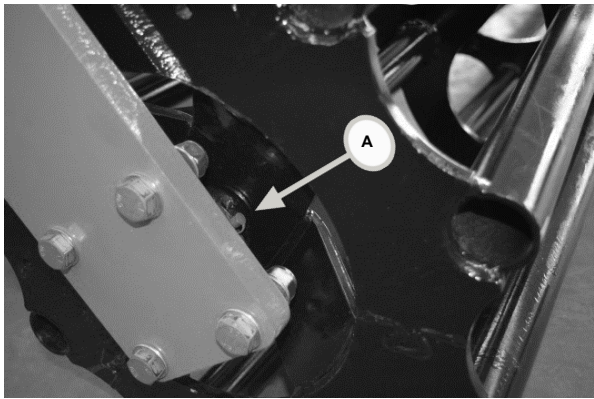
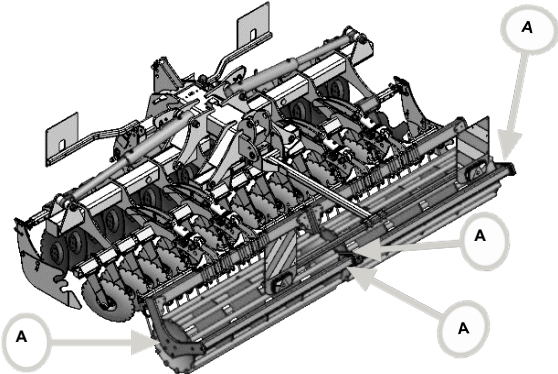
 Fig. 25	 Fig. 26
---	--

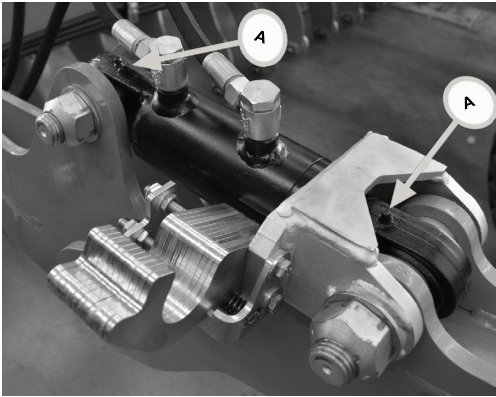
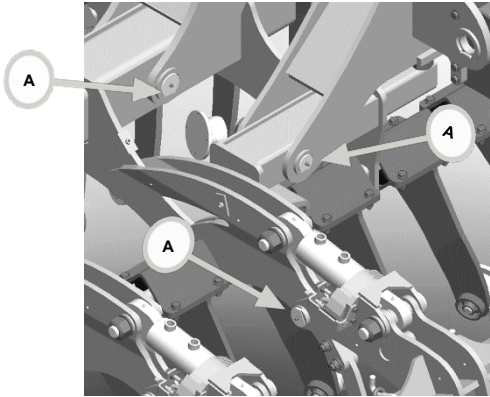
 Fig. 27	 Fig. 28
--	---

Lubrication points (A) shall be lubricated all 10 hours

7.3 Definition of terms

terms	lubricants	Place/amount	specials
grease	Multy puprose oil	Grease nipples / approx. 1 squirts out of grease gun	remove excess grease on grease nipple

7.4 Lubrication points

Please clean the nipples and put one or two drops of grease on the parts. Remove excess grease and keep it away from the parts. Please use exclusively grease of type molybdenum sulphite NLGI No 2 for wheel axles.

8. DISPOSAL

<p>Fig. 29</p> 	<p>Oils, grease and waste tainted with it are a great danger for the environment and have to be disposed appropriately and according to legal requirements.</p>
--	---

<p>Fig. 30</p> 	<p>Decommissioning If the disc harrows' and its components' use has expired and therefore the machines have to be sent to final scrapping, all components have to be separated according to its materials and have to be disposed environmentally compatible or recycled. Please adhere to current requirements.</p>
---	---

1. DISPOSAL /
TIGHTENING TORQUE FOR SCREWS

9. TIGHTENING TORQUE FOR SCREWS

Tightening torque for galvanized screws

Strength class	Tightening torque Nm	NOMINAL DIAMETER - NORMAL THREAD																		
		M3	M4	M5	M6	M7	M8	M10	M12	M14	M16	M18	M20	M22	M24	M27	M30	M33	M36	M39
5.6	Nm	0.56	1.28	2.50	4.3	7.1	10.5	21	36	58	88	121	171	230	295	435	590	800	1030	1340
	ft/lb	0.41	0.94	1.84	3.1	5.2	7.7	15	26	42	64	89	126	169	217	320	435	590	759	988
8.8	Nm	1.28	2.90	5.75	9.9	16.5	24	48	83	132	200	275	390	530	675	995	1350	1830	2360	3050
	ft/lb	0.94	2.14	4.24	7.3	12.1	17.7	35	61	97	147	202	287	390	497	733	995	1349	1740	2249
10.9	Nm	1.80	4.10	8.1	14	23	34	67	117	185	285	390	550	745	960	1400	1900	2580	3310	4290
	ft/lb	1.33	3.02	5.97	10.3	16.9	25	49	86.2	136	210	287	405	549	708	1032	1401	1902	2441	3163
12.9	Nm	2.15	4.95	9.70	16.5	27	40	81	140	220	340	470	660	890	1140	1680	2280	3090	3980	5150
	ft/lb	1.59	3.65	7.15	12.1	19.9	29	59	103	162	250	346	486	656	840	1239	1681	2278	2935	3798

Strength class	Tightening torque Nm	NOMINAL DIAMETER - FINE THREAD								
		M8 x 1	M10 x 1.25	M12 x 1.25	M14 x 1.5	M16 x 1.5	M18 x 1.5	M20 x 1.5	M22 x 1.5	M24 x 2
8.8	Nm	25	49	88	140	210	305	425	570	720
	ft/lb	18	36	64	103	154	224	313	420	531
10.9	Nm	35	68	125	195	295	425	600	800	1000
	ft/lb	25	50	92	143	217	313	442	590	737
12.9	Nm	42	82	150	235	350	510	720	960	1200
	ft/lb	30	60	110	173	258	376	531	708	885

ZIEGLER |

Hersteller:

ZIEGLER GmbH

Schrobenhausener Straße 56

D-86554 Pöttmes

Tel: +49 (0) 82 53 / 99 97-0

Fax: +49 (0) 82 53 / 99 97-47

Web: www.ziegler-gmbh.com

Amtsgericht Augsburg HR-NR. B 17559

Erfüllungsort Pöttmes, Gerichtsstand Aichach

Steuer-Nr. 102/168/10401

Geschäftsführer: M. Ziegler, Dipl. BW (FH)

Manufacturer:

ZIEGLER GmbH

Schrobenhausener Straße 56

86554 Pöttmes

Germany

Phone: +49 (0) 82 53 / 99 97-0

Fax: +49 (0) 82 53 / 99 97-47

Web: www.ziegler-gmbh.com

Local Court of Augsburg,

commercial register no. HRB 17559

Place of performance: Pöttmes, Place of

jurisdiction: Aichach

Tax no. 102/168/10401

Managing director: M. Ziegler, Dipl. BW (FH)

Производитель:

ZIEGLER GmbH

Schrobenhausener Straße 56

D-86554 Pöttmes

Tel: +49 (0) 82 53 / 99 97-0

Fax: +49 (0) 82 53 / 99 97-47

Web: www.ziegler-gmbh.com

Amtsgericht Augsburg HR-NR. B 17559

Erfüllungsort Pöttmes, Gerichtsstand Aichach

Steuer-Nr. 102/168/10401

Geschäftsführer: M. Ziegler, Dipl. BW (FH)